

FERROXCUBE

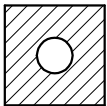

1 2 3 4

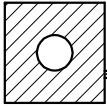
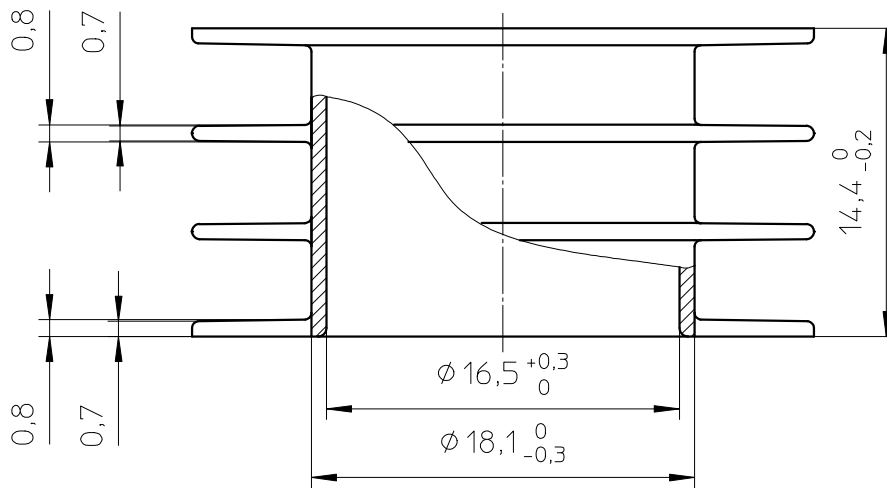
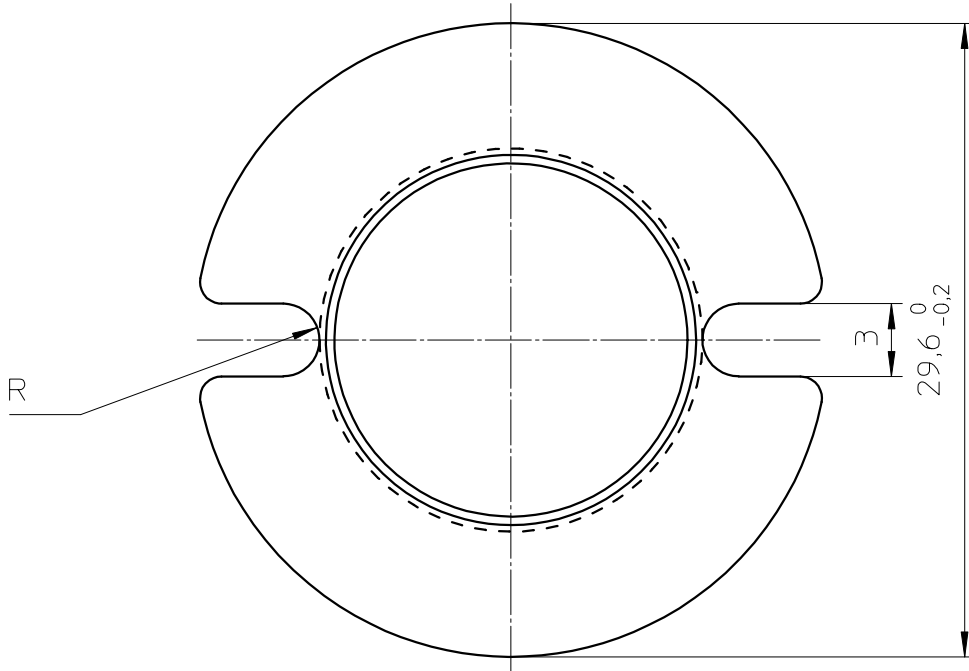

Coil former material: Valox 420SE0 (PBT), glass-reinforced.
 UL file number: E45329 - UL94V-0.
 Max. operating temp.: acc. to IEC 60 085 class F, 155°C.
 Min. winding area: 63,2 mm².
 Mean length of turn: 74,3 mm.

CLASS.NO.		CP-P36/22-3S		4322 021 02521		97-08-22		
00-07-24						00-07-24		
NAME NAAM	M.Veekens	SUPERS. VERV.	4322 021 30412	1 SH BL	112	- 001	010	A4
MPA	CHECK CONTR.	DAT.	97-08-22	Property of Eigendom van		© FERROXCUBE 2000		