

M12

Right Angle Connectors



Full-Scale 5-pin Female Connector

M12 - Right Angle Connectors

GENERAL

STANDARD SOLUTIONS

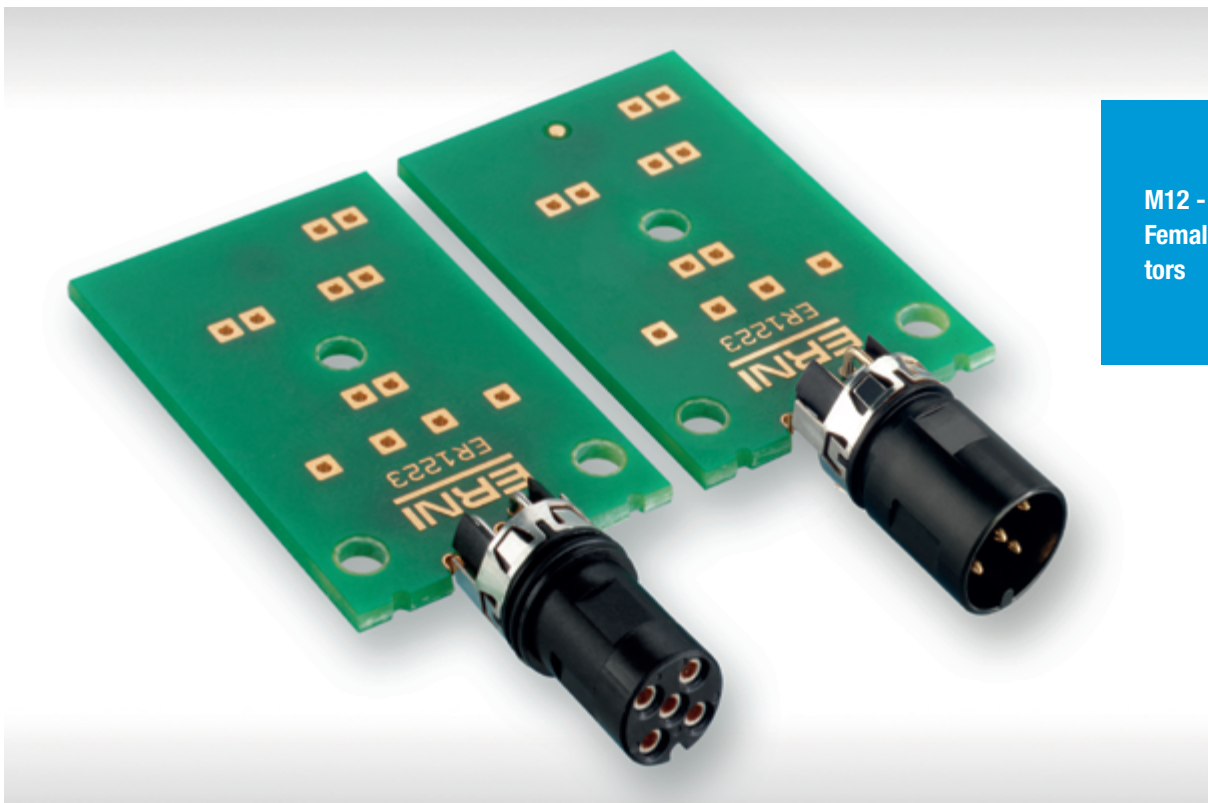

M12 - Male and Female Connectors

Design Features

- extremely space saving due to be placed on PCB central axis
- identical Layout for male and female version
- 4 - 8 pin configuration
- gold plated contacts
- IP 65/67 mated and locked condition
- suitable for potting after assembly due to optional O-Ring
- male and female can be used with housings which provide integrated M12 threads
- optional 360° shield ring
- integrated brackets for 3 different frequently-used PCB thicknesses, 1.0 / 1.6 / 2.0 mm
- cylindrical base version, which is also usable for M12 sensor pipes
- high CTI-value of 600 for rough environmental applications
- UL listed polymer plastic
- early mate last break option for pin 5
- mating side according IEC 61076 – 2 – 101
- A-, B- and D-Coding
- UL E84703 listed

M12 - Right Angle Connectors

GENERAL

STANDARD SOLUTIONS

Processing Features

- first M12 90° version which has full capability for automated pick and place assembly
- T&R packaging
- integrated pick & place area
- pegs and integrated PCB support areas ensure a secure position while soldering
- extremely robust due to pins soldered on top and bottom side of the PCB
- lead-free reflow compatible
- rear mounting of the final assembled PCB in a housing

For technical data refer to **ERNI document 225407**

SENSOR PIPE SOLUTIONS

This new development is an innovative product that have never been existed before. It completes the ERNI M12 connector range with a M12 male connector which targets specially the sensor industry, where mostly one single male connector is used for a device. To save cost and ensure high quality levels, the connector can be fully handled within a standard SMT assembly line.

Mating side according IEC 61076 – 2 – 101.



Design Features

- extremely short version 14 mm length
- specially designed for M12 sensor pipes
- front mounting of final assembled PCB into the sensor pipe
- sealing option with O-ring
- versions with anti twist protection
- additional features see standard version

M12 - Right Angle Connectors

ASSEMBLY AND SOLDER RECOMMENDATIONS

PCB THICKNESS

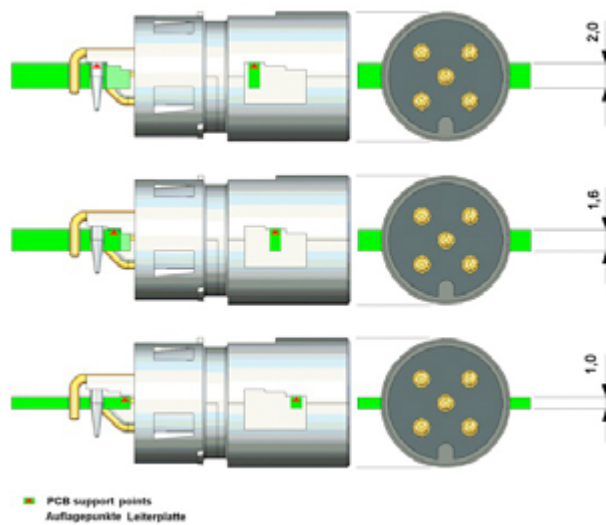

The connector has integrated PCB support points, which are able to adapt the 3 frequently-used PCB thicknesses. The thickest PCB could be 2.0 mm followed by the favorite 1.6 mm and further followed by the thinnest 1.0 mm.

Note: Also other thicknesses in between of the mentioned range can be used, if the non centric position of the connector, in this case is taken into account. The support points have to be considered according the chosen PCB thickness, see drawing left hand side. The PCB has to be designed to provide those supports.

For exact dimensions, mechanical CAD-files can be provided.

ASSEMBLY PROCESS

Printing of solder paste

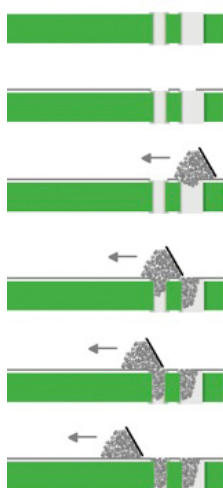

Automated Assembly

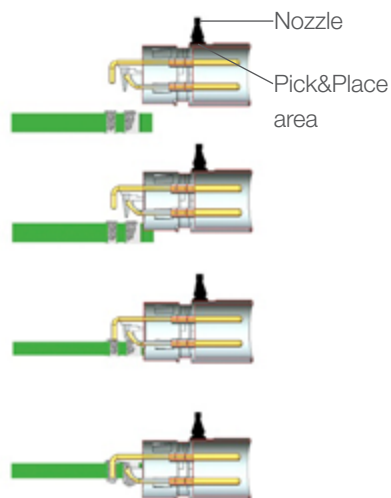

Bemerkungen

- generally a certain mounting force is required when using the THR solder process
- Special-Nozzles may be necessary
- machine capability must be checked upfront

M12 - Right Angle Connectors

DIMENSIONS AND ASSEMBLY RECOMMENDATION STANDARD

M12 MALE (5-PIN) WITH ERNI LOCKING SHELL

Gewinde-Löcher / Thread holes

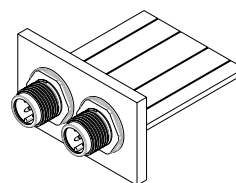
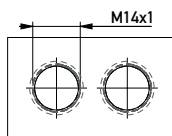
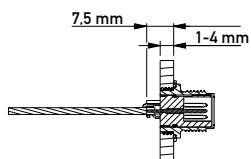
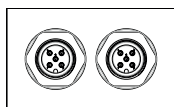

Standard-Löcher / Standard holes

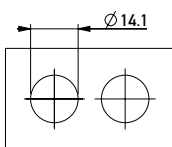
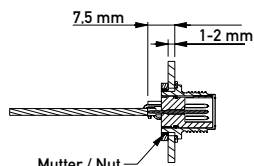
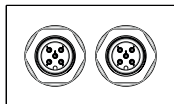

Montageloch für Verdreherschutz / Assembly hole for twist protection

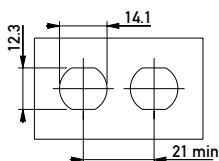
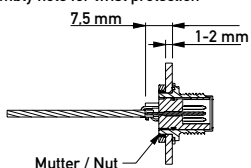
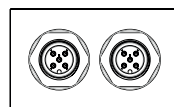

M12 FEMALE (5-PIN) WITH ERNI LOCKING SHELL

Gewinde-Löcher / Thread holes

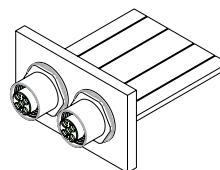
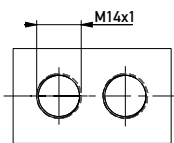
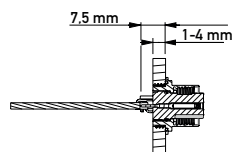
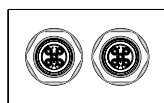

Standard-Löcher / Standard holes

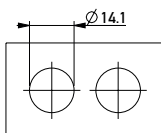
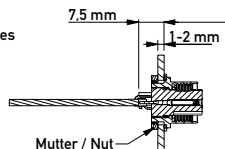
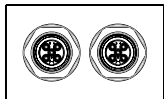

Montageloch für Verdreherschutz / Assembly hole for twist protection

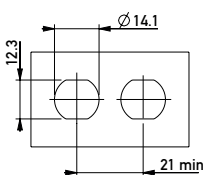
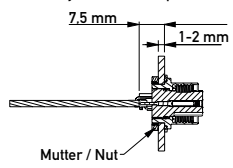
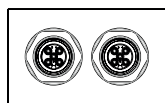

See product drawing or recommendations for use the M12 90° connectors together with housings which have already an integrated M12 thread (**ERNI document 225406**).

M12 - Right Angle Connectors

ASSEMBLY EXAMPLE FOR SENSOR PIPE

REAR MOUNTING SENSOR PIPE



→ PCB mounting direction

FRONT MOUNTING SENSOR PIPE



← PCB mounting direction

M12 - Right Angle Connectors

LAYOUT, SHIELDING, PACKAGING AND SEALING OPTIONS

LAYOUT RECOMMENDATION

Sensor Pipe Application

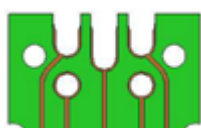

Unshielded version

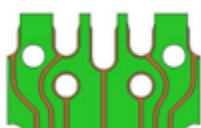

Shielded version



Solder paste

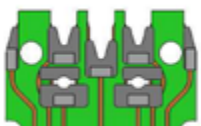

Solder paste with solder Preform

Standard Application

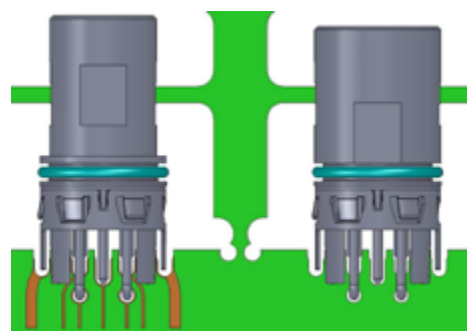

5-pin version please refer to **document 225321**; 8-pin version refer to **document 225508**

SHIELDING

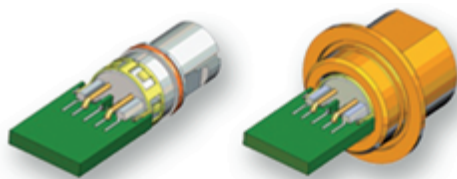

The optional shield ring is soldered with two pins to the pcb.
Electrical contact to the locking shell is given by three contact tongues placed at the outer contour of the shield ring.

PACKAGING

Verpackt in Gurtverpackung - *Tape on Reel Packaging*
Verpackungseinheit: 250 Stück - *Packaging unit: 250 pcs*

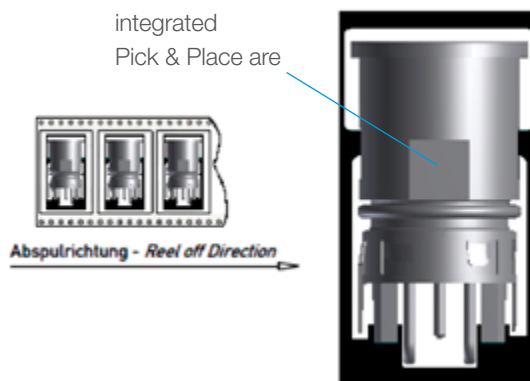
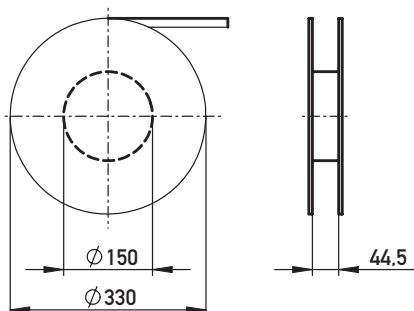

M12 - Right Angle Connectors

LAYOUT, SHIELDING, PACKAGING AND SEALING OPTIONS

SEALING OPTIONS M12 90° MALE CONNECTORS

O-Ring sealing; locking shell / customer housing

O-Ring sealing; connector / locking shell

Minimal air gap at the stopping edge for resin, if potting is applied

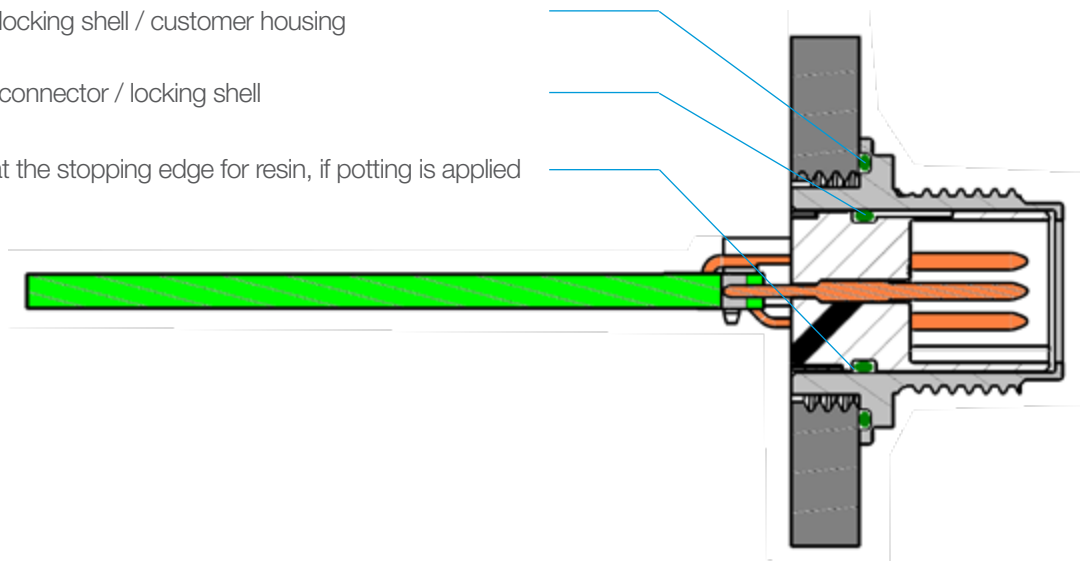

SEALING OPTIONS M12 90° FEMALE CONNECTORS

Identical to male version; but an additional O-Ring is needed for sealing the connector interface acc. IEC-Standard.

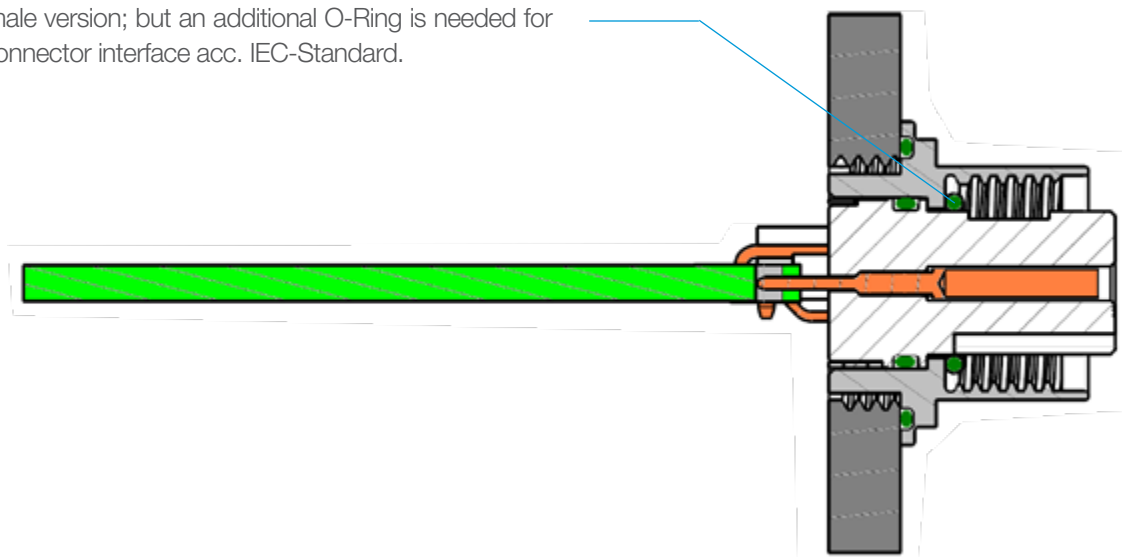

M12 - Right Angle Connectors

MALE CONNECTORS FOR STANDARD APPLICATIONS

END ASSEMBLY REAR MOUNT



- right angle male
- rear mount
- with or without O-Ring
- 4, 5 and 8-pin
- shielded and unshielded versions

No. of Pins	Coding	Loaded Pins	O-Ring	Part Number unshielded	Part Number shielded
4	A	1, 2, 3, 4	no	225252	225255
4	A	1, 2, 3, 4	yes	–	235171
4	D	1, 2, 3, 4	no	225263	225264
5	A	1, 2, 3, 4, 5	no	225251	225254
5	A	1, 2, 3, 4, 5	yes	225456	235165
5	A	1, 2, 3, 4, 5v	no	225253	225256
5	B	1, 2, 3, 4, 5	no	225258	225260
8	A	1, 2, 3, 4, 5, 6, 7, 8	no	225294	225295
8	A	1, 2, 3, 4, 5, 6, 7, 8	yes	225454	235045

v = early mate last break

M12 - Right Angle Connectors

MALE CONNECTORS FOR STANDARD APPLICATIONS

END ASSEMBLY REAR MOUNT AND ADDITIONAL ANTI TWIST PROTECTION

No. of Pins	Coding	Loaded Pins	O-Ring	Part Number unshielded	Part Number shielded
8	A	1, 2, 3, 4, 5, 6, 7, 8	yes	225614	–

Used with locking shell 225635.

OPTIONAL ACCESSORIES

Description	Usage	Part Number
O-Ring, 7.2 x 0.8, Viton	sealing option between connector and locking shell	225360
M12 Locking shell	for male connectors	225361
M12 Locking shell	for male connectors with anti twist protection	225635
O-Ring, 14 x 1	sealing option between housing and locking shell	834899
M12 Protection cap	for male connectors	374342
Counternut	for locking shell	354003

M12 - Right Angle Connectors

MALE CONNECTORS FOR STANDARD APPLICATIONS

END ASSEMBLY REAR MOUNT, DI TYPE



- right angle male
- rear mount, DI
- with or without O-Ring
- 4, 5 and 8-pin
- shielded and unshielded versions

No. of Pins	Coding	Loaded Pins	O-Ring	Part Number unshielded	Part Number shielded
4	by customer	1, 2, 3, 4	no	225267	225270
4	by customer	1, 2, 3, 4	yes	235042	–
5	by customer	1, 2, 3, 4, 5	no	225266	225269
5	by customer	1, 2, 3, 4, 5v	no	225268	225271
8	by customer	1, 2, 3, 4, 5, 6, 7, 8	no	225297	225298

v = early mate last break

OPTIONAL ACCESSORIES

Description	Usage	Part Number
O-Ring, 7.2 x 0.8, Viton	Sealing option between connector and customer housing	225360

O-Ring can be used in reflow solder process.

M12 - Right Angle Connectors

MALE CONNECTORS FOR SENSOR PIPE APPLICATIONS

END ASSEMBLY FRONT MOUNT



- right angle male
- front mount
- with O-Ring
- 4, 5 and 8-pin
- shielded and unshielded versions

No. of Pins	Coding	Loaded Pins	O-Ring	Part Number unshielded	Part Number shielded
4	A	1, 2, 3, 4	yes	225243	225247
5	A	1, 2, 3, 4, 5	yes	225242	225246
5	A	1, 2, 3, 4, 5v	yes	225245	225249
8	A	1, 2, 3, 4, 5, 6, 7, 8	yes	225291	225292

v = early mate last break

OPTIONAL ACCESSORIES

Description	Usage	Part Number
M12 Protection cap	for male connectors	374342

M12 - Right Angle Connectors

MALE CONNECTORS FOR SENSOR PIPE APPLICATIONS

END ASSEMBLY FRONT MOUNT, ANTI TWIST VERSION

No. of Pins	Coding	Loaded Pins	O-Ring	Part Number unshielded	Part Number shielded
4	A	1, 2, 3, 4	yes	225516	225519
5	A	1, 2, 3, 4, 5	yes	225515	225518
8	A	1, 2, 3, 4, 5, 6, 7, 8	yes	225521	225522



END ASSEMBLY FRONT MOUNT, SNAP-IN VERSION

No. of Pins	Coding	Loaded Pins	O-Ring	Part Number unshielded	Part Number shielded
5	A	1, 2, 3, 4, 5	yes	225459	–

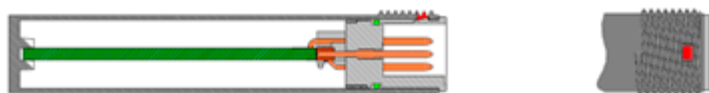

M12 - Right Angle Connectors

FEMALE CONNECTORS FOR STANDARD APPLICATIONS

END ASSEMBLY REAR MOUNT



- right angle female
- rear mount
- with or without O-Ring
- 4, 5 and 8-pin
- shielded and unshielded versions

No. of Pins	Coding	Loaded Pins	O-Ring	Part Number unshielded	Part Number shielded
4	A	1, 2, 3, 4	no	225274	225276
4	A	1, 2, 3, 4	yes	225458	–
4	D	1, 2, 3, 4	no	225283	225284
5	A	1, 2, 3, 4, 5	no	225273	225275
5	A	1, 2, 3, 4, 5	yes	225457	235164
5	B	1, 2, 3, 4, 5	no	225278	225280
8	A	1, 2, 3, 4, 5, 6, 7, 8	no	225300	225301
8	A	1, 2, 3, 4, 5, 6, 7, 8	yes	225455	–

M12 - Right Angle Connectors

FEMALE CONNECTORS FOR STANDARD APPLICATIONS

END ASSEMBLY REAR MOUNT AND ADDITIONAL ANTI TWIST PROTECTION

No. of Pins	Coding	Loaded Pins	O-Ring	Part Number unshielded	Part Number shielded
8	A	1, 2, 3, 4, 5, 6, 7, 8	yes	225615	–

Used with locking shell 225636.

OPTIONAL ACCESSORIES

Description	Usage	Part Number
O-Ring, 7.2 x 0.8, Viton	sealing option between connector and locking shell	225360
O-Ring, 7 x 1, Viton	sealing option cable side	835284
O-Ring, 8.1 x 1.6, Viton	sealing option cable side alternativ	225588
M12 Locking shell	for female connectors	225362
M12 Locking shell	for female connectors with anti twist protection	225636
O-Ring, 14 x 1	sealing option between housing and locking shell	834899
M12 Protection cap	for female connectors	347343
Counternut	for locking shell	354003

M12 - Right Angle Connectors

FEMALE CONNECTORS FOR STANDARD APPLICATIONS

END ASSEMBLY REAR MOUNT, DI TYP



- right angle female
- rear mount, DI
- with or without O-Ring
- 4, 5 and 8-pin
- shielded and unshielded versions

No. of Pins	Coding	Loaded Pins	O-Ring	Part Number unshielded	Part Number shielded
4	by customer	1, 2, 3, 4	no	225287	225289
5	by customer	1, 2, 3, 4, 5	no	225286	225288
8	by customer	1, 2, 3, 4, 5, 6, 7, 8	no	225303	225304

OPTIONAL ACCESSORIES

Description	Usage	Part Number
O-Ring, 7.2 x 0.8, Viton	sealing option between connector and customer housing	225360
O-Ring, 7 x 1, Viton	sealing option cable side	835284

O-Ring 225360 can be used in reflow solder process.

M12 - Right Angle Connectors

ASSEMBLY

PROCESS IMAGES

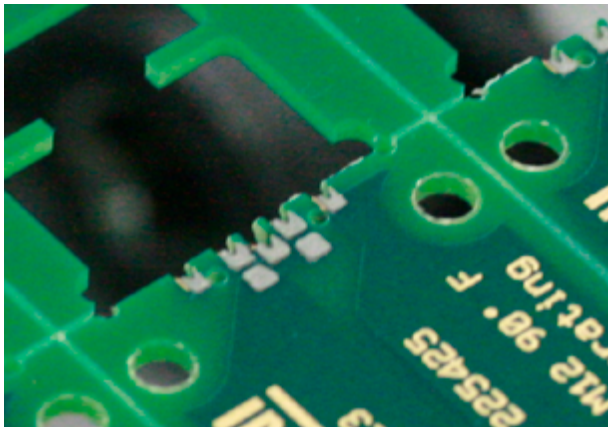

PCB with solder paste

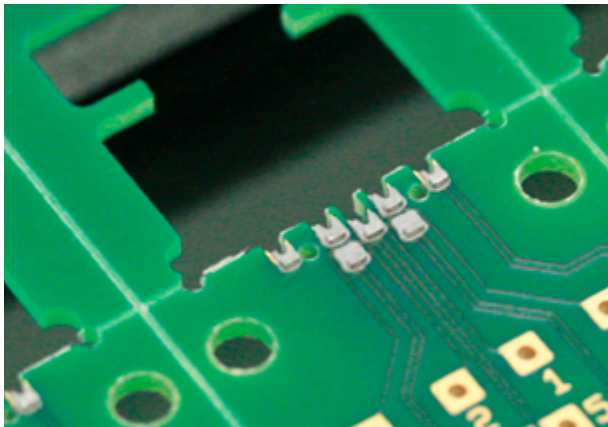

PCB with solder paste and Pre-Form

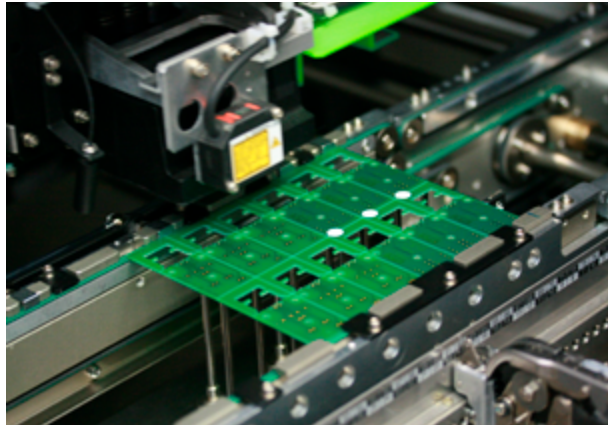

Multiple printed pcb in assembly machine

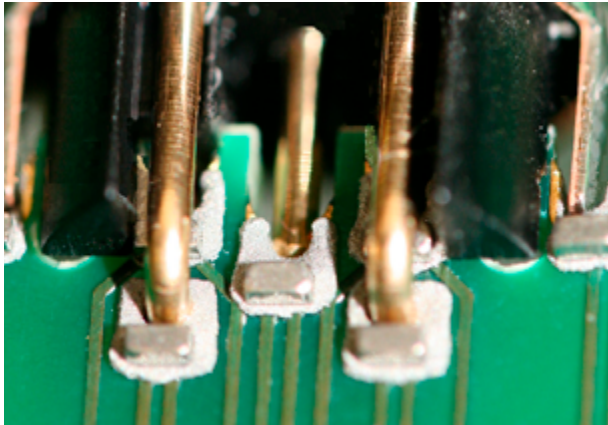

Connector placed into solder paste



Male solder joints



Female solder joints

M12 - Right Angle Connectors

ASSEMBLY

PRODUCT IMAGES

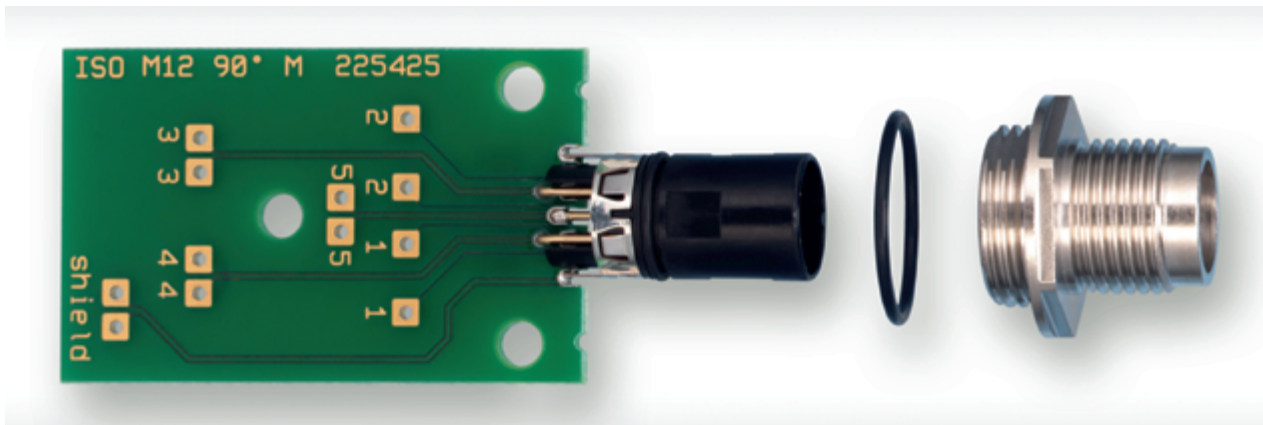
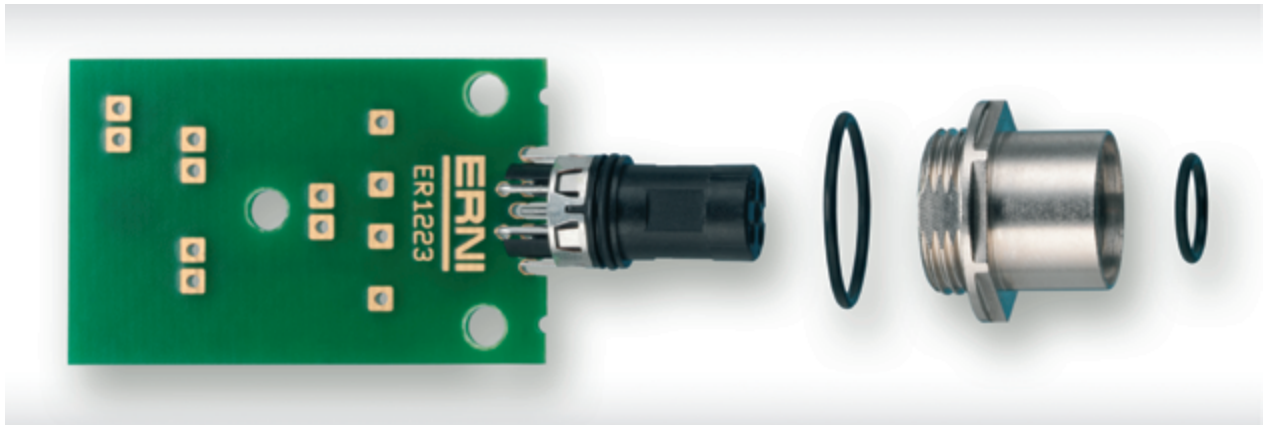
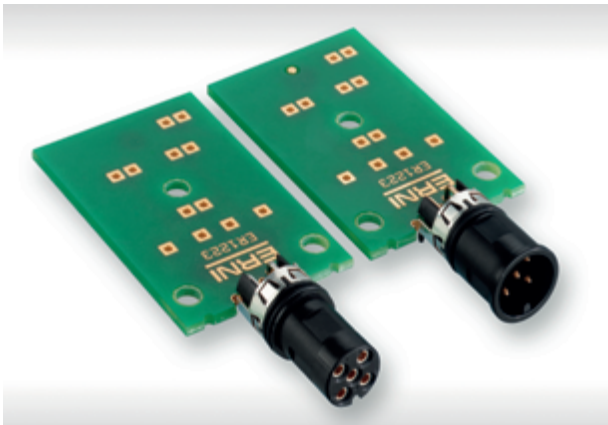
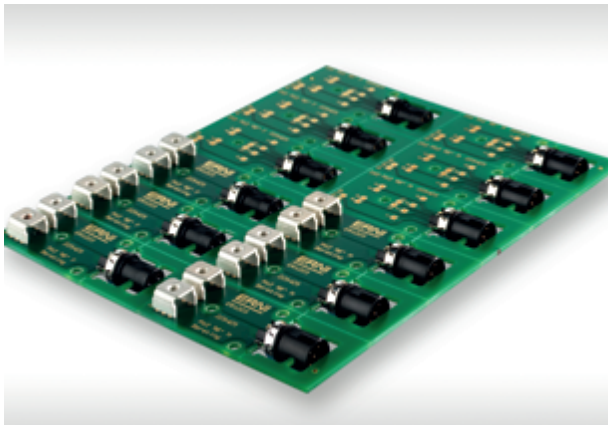



Find your correct contact person
on [erni.com/locations](https://www.erni.com/locations)