

Schemazeichnung | Schematic drawing

0986 h=11

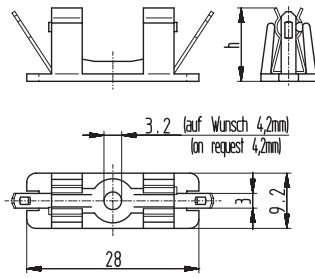

S 2.8/0.8

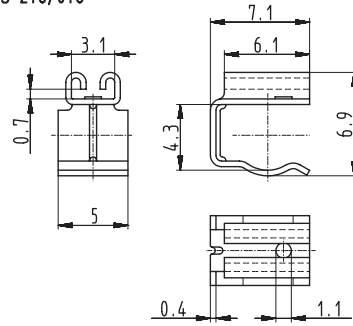

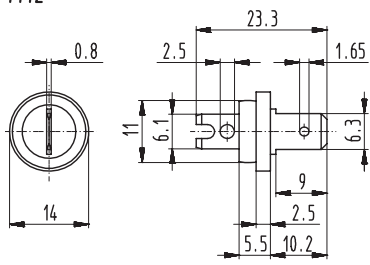

7772

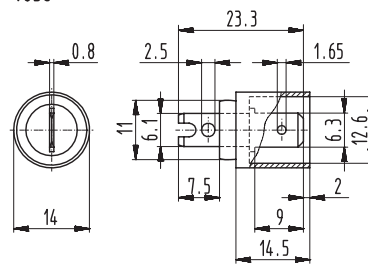

7856

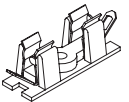
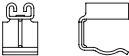

	Zubehör Accessories	Sicherungshalter, Durchführung Fuse holder, Bushing	Sonstiges General
	Stück pro Packung Packing unit	Bestellbezeichnung Type	Ausführungsart Version
		Sicherungshalter zum Nieten, Wz 0986 Fuse holder for rivet fixing, Wz 0986	2614 
2000		Sicherungshalter S 2,8/0,8 Fuse holder S2,8/0,8	367 
		Durchführung DF 6,3 x 0,8 - Wz 7772 Bushing DF 6,3 x 0,8 - Wz 7772	3518 
		Durchführung DF 6,3 x 0,8/mB mit Berührungsschutz, Wz 7856 Bushing DF 6,3 x 0,8/mB with contact protection, Wz 7856	3623 